



MITSUBISHI L200 (Triton) (KA; KB; 2,5 TD)

2007

14.1143/14.1144

05/03/13

1/6



GB Location/Position Arrow

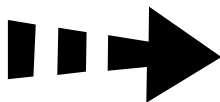

GB Movement Arrow



GB Screw Arrow

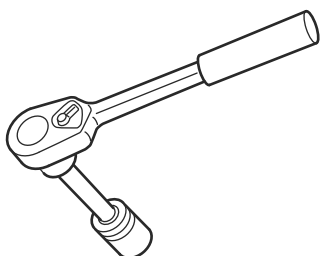
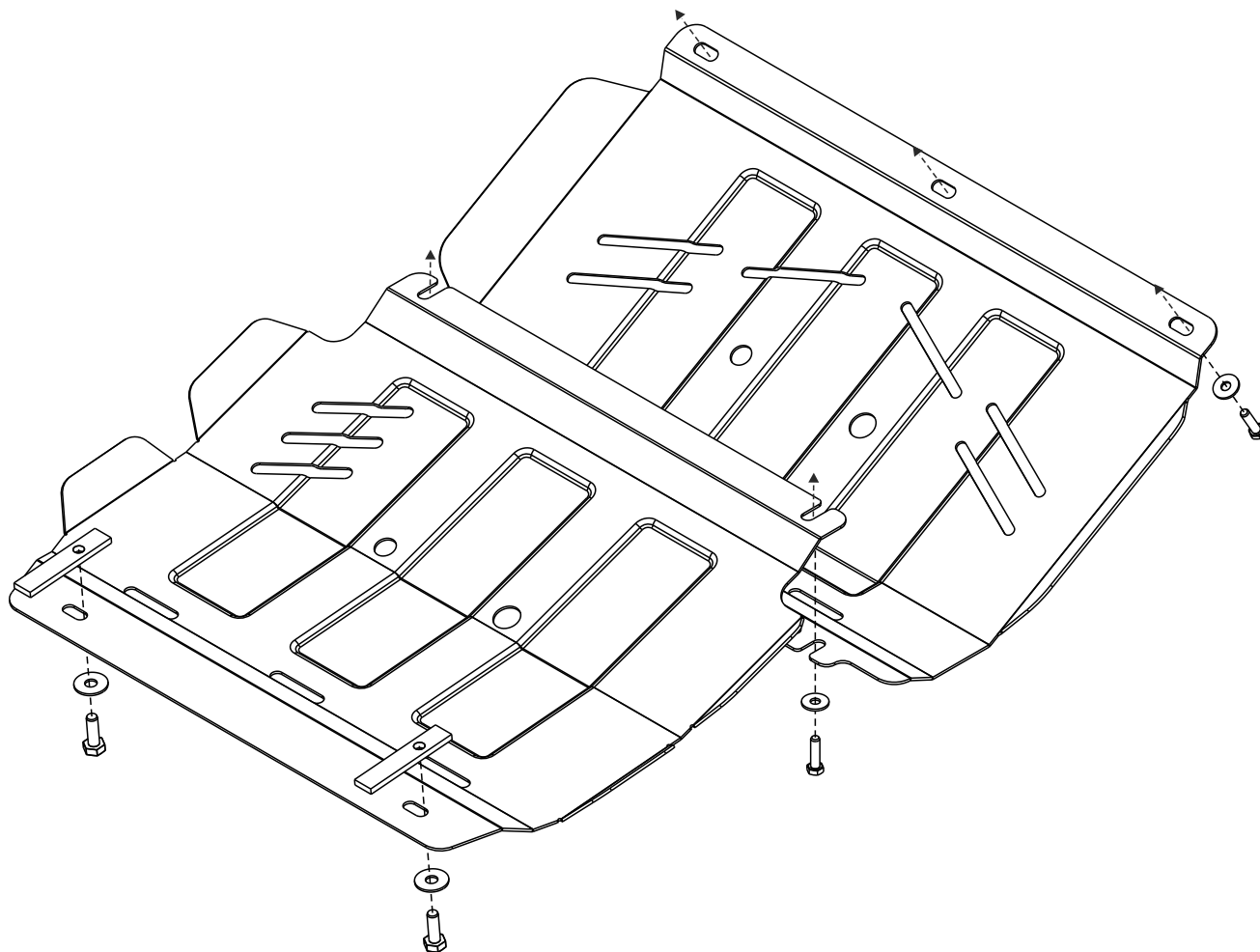

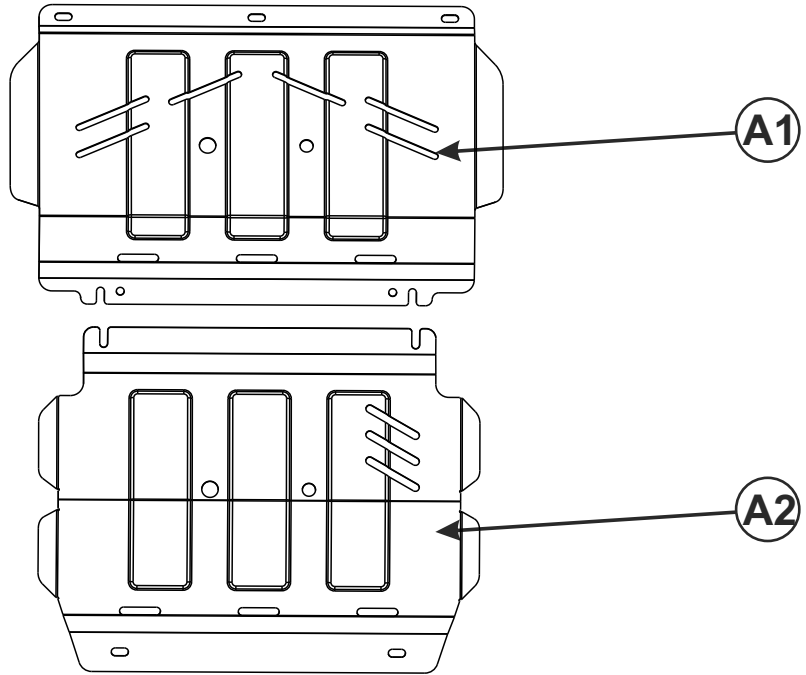
A

1X

1X

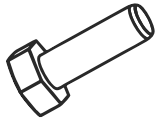
B

M8x30

5X

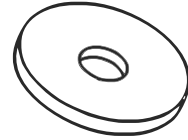
C

Ø 8

5X

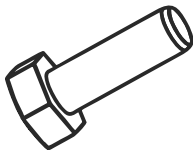
D

M10x30

2X

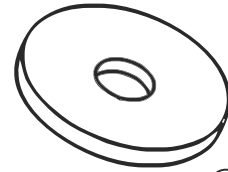
E

Ø 10

2X

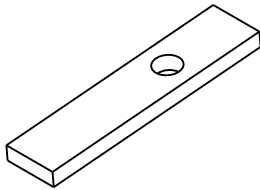
F

2X

